

# MICROPROCESSOR OVERCURRENT and EARTH FAULT RELAY

TYPE

## MC20-X/10-4

(I/O Boards)

# OPERATION MANUAL



<b>1. General Utilization and Commissioning Directions</b>	<b>3</b>
1.1 - Storage and Transportation	3
1.2 - Installation	3
1.3 - Electrical Connection	3
1.4 - Measuring Inputs and Power Supply	3
1.5 - Outputs Loading	3
1.6 - Protection Earthing	3
1.7 - Setting and Calibration	3
1.8 - Safety Protection	3
1.9 - Handling	3
1.10 - Maintenance	4
1.11 - Waste Disposal of Electrical & Electronic Equipment	4
1.12 - Fault detection and repair	4
<b>2. General Characteristics</b>	<b>5</b>
2.1 - Power Supply	5
2.2 - Operation and Algorithms	6
2.2.1 - Reference Input Values	6
2.2.2 - Input quantities	6
2.2.2.1 - Mains Frequency (Freq)	6
2.2.2.2 - Phase Current inputs (I1)	6
2.2.2.3 - Earth Fault Current Input (Ion)	7
2.2.2.4 - Algorithm of the time current curves	7
2.2.3 - Time Current Curves IEC (TU1029 Rev.0)	8
2.2.4 - Time Current Curves IEEE (TU1028 Rev.0)	9
2.2.5 - Functions and Settings (Function)	10
2.2.5.1 - I> (1F51) - First overcurrent protection level	10
2.2.5.2 - I>> (2F51) - Second overcurrent protection level	10
2.2.5.3 - IH (3F51) - Third overcurrent protection level	11
2.2.5.5 - Io> (1F51N) - First Earth Fault protection level	12
2.2.5.6 - Io>> (2F51N) - Second Earth Fault protection level	12
2.2.5.7 - IoH (3F51N) - Third Earth Fault protection level	13
2.2.5.8 - BF (F51BF) - Breaker Failure	13
2.2.5.9 - RTD - Remote Trip	13
2.2.5.10 - I.R.F. - Internal Relay Failure	14
2.2.5.11 - Osc - Oscillographic Recording	14
2.2.5.12 - Comm - Communication Parameters	15
2.2.5.13 - LCD - Display and Buzzer operation	15
<b>3. Logic Blocking of Functions</b>	<b>16</b>
3.1 - Blocking output	16
3.2 - Blocking Input	16
<b>4. Output Relays</b>	<b>16</b>
<b>5. Digital Inputs</b>	<b>17</b>
<b>6. Self-diagnostic</b>	<b>17</b>
<b>7. Relay Management</b>	<b>18</b>
<b>8. Signalizations</b>	<b>19</b>
<b>9. Keyboard Buttons</b>	<b>19</b>
<b>10. Serial Communication Port</b>	<b>20</b>
10.1 - Main RS485 Serial Communication Port	20
10.2 - Communication Port on Front Face Panel	21
<b>11. Menu and Variables</b>	<b>22</b>
11.1 - Real Time Measurements	22
11.2 - Meas (Instantaneous Measurements)	22
11.3 - Counter (Operation Counters)	22
11.4 - LastTrip (Event Recording)	23
11.5 - R/W Set (Programming / Reading the Relay Settings)	24
11.5.1 - CommAdd (Communication Address)	24
11.5.2 - Time/Date (Time/Date)	24
11.5.3 - RatedVal (Rated Input Values)	24
11.5.4 - Function (Functions)	25
11.6 - RelayCfg (Relay Configuration)	27
11.7 - Commands	28
11.8 - Info&Ver (Firmware - Info&Version)	28
<b>12. KEYBOARD OPERATIONAL DIAGRAM</b>	<b>29</b>
<b>13. Password</b>	<b>31</b>
13.1 - MS-Com Password	31
<b>14. Maintenance</b>	<b>31</b>
<b>15. Power Frequency Insulation Test</b>	<b>31</b>
<b>16. Connection Diagram</b>	<b>32</b>
16.1 - UX10-4 - Expansion Module - Wiring Diagram (10 Digital Inputs + 4 Output Relays)	32
<b>17. Overall Dimensions</b>	<b>33</b>
<b>18. Direction for Pcb's Draw-Out and Plug-In</b>	<b>34</b>
18.1 - Draw-Out	34
18.2 - Plug-In	34
<b>19. Electrical Characteristics</b>	<b>35</b>

---

**1. General Utilization and Commissioning Directions**

---

Always make reference to the specific description of the product and to the Manufacturer's instruction. Carefully observe the following warnings.

---

**1.1 - Storage and Transportation**

---

must comply with the environmental conditions stated on the product's instruction or by the applicable IEC standards.

---

**1.2 - Installation**

---

must be properly made and in compliance with the operational ambient conditions stated by the Manufacturer.

---

**1.3 - Electrical Connection**

---

must be made strictly according to the wiring diagram supplied with the Product, to its electrical characteristics and in compliance with the applicable standards particularly with reference to human safety.

---

**1.4 - Measuring Inputs and Power Supply**

---

carefully check that the value of input quantities and power supply voltage are proper and within the permissible variation limits.

---

**1.5 - Outputs Loading**

---

must be compatible with their declared performance.

---

**1.6 - Protection Earthing**

---

When earthing is required, carefully check its effectiveness.

---

**1.7 - Setting and Calibration**

---

Carefully check the proper setting of the different functions according to the configuration of the protected system, the safety regulations and the co-ordination with other equipment.

---

**1.8 - Safety Protection**

---

Carefully check that all safety means are correctly mounted, apply proper seals where required and periodically check their integrity.

---

**1.9 - Handling**

---

Notwithstanding the highest practicable protection means used in designing M.S. electronic circuits, the electronic components and semiconductor devices mounted on the modules can be seriously damaged by electrostatic voltage discharge which can be experienced when handling the modules.

The damage caused by electrostatic discharge may not be immediately apparent but the design reliability and the long life of the product will have been reduced. The electronic circuits reduced by M.S. are completely safe from electrostatic discharge (8 KV IEC 255.22.2) when housed in their case; withdrawing the modules without proper cautions expose them to the risk of damage.

- a. Before removing a module, ensure that you are at the same electrostatic potential as the equipment by touching the case.
- b. Handle the module by its front-plate, frame, or edges of the printed circuit board. Avoid touching the electronic components, printed circuit tracks or connectors.
- c. Do not pass the module to any person without first ensuring that you are both at the same electrostatic potential. Shaking hands achieves equipotential.
- d. Place the module on an antistatic surface, or on a conducting surface which is at the same potential as yourself.
- e. Store or transport the module in a conductive bag.

More information on safe working procedures for all electronic equipment can be found in BS5783 and IEC 147-OF.

### ***1.10 - Maintenance***

---

Make reference to the instruction manual of the Manufacturer ; maintenance must be carried-out by specially trained people and in strict conformity with the safety regulations.

### ***1.11 - Waste Disposal of Electrical & Electronic Equipment***

---

(Applicable throughout the European Union and other European countries with separate collection program).

This product should not be treated as household waste when you wish dispose of it. Instead, it should be handed over to an applicable collection point for the recycling of electrical and electronic equipment. By ensuring this product is disposed of correctly, you will help prevent potential negative consequence to the environment and human health, which could otherwise be caused by inappropriate disposal of this product. The recycling of materials will help to conserve natural resource.

### ***1.12 - Fault detection and repair***

---

Internal calibrations and components should not be altered or replaced.  
For repair please ask the Manufacturer or its authorised Dealers.

Misapplication of the above warnings and instruction relieves the Manufacturer of any liability.

**2. General Characteristics**

The MC is a very innovative and versatile line of Protective Relays which takes advantage of the long and successful experience coming from the M-Line.

The main features of the MC-Line relays are:

Compact draw-out execution for Flush Mounting or for assembly in 19" 3U chassis for 19" Rack systems.

User friendly front face with 2x8 characters LCD Display, four signal Leds, four keys for complete local management and 9-pin socket for local RS232 serial communication.

Four user programmable Output Relays. On request one of the Output Relays can be replaced by a Can Bus port for control of additional I/O modules.

Three optoisolated, selfpowered Digital Inputs.

RS485 communication port (independent from the RS232 port on front panel)

Totally draw-out execution with automatic C.T. shorting device.

Input currents are supplied to 3 current transformers: - two measuring phase current - one measuring the earth fault zero-sequence current.

Current inputs can be 1 or 5A, selection between 1A or 5A is made by movable jumpers provided on the Relay card. (see Fig 1)

**The Measuring Ranges of the different inputs respectively are:**

- Phase Currents : (0.1-40)In
- Neutral Current : (0.01-10)On

Make electric connection in conformity with the diagram reported on relay's enclosure.

Check that input currents are same as reported on the diagram and on the test certificate.

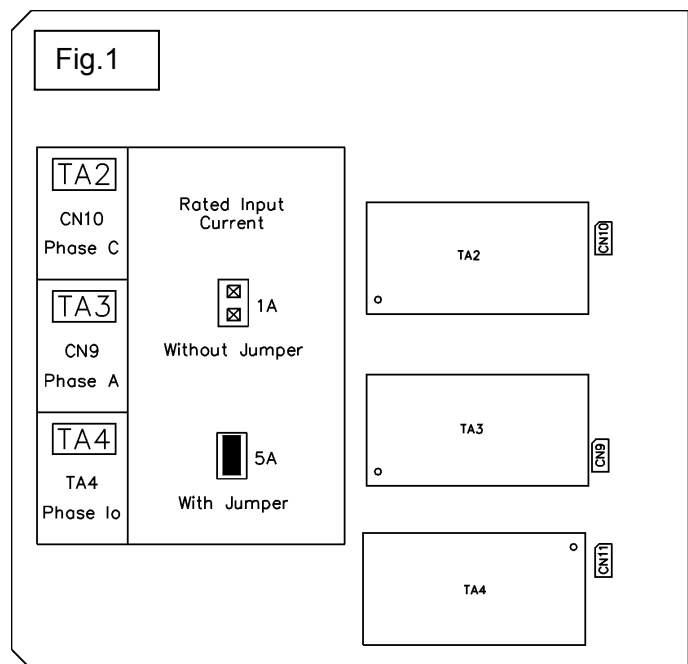

**2.1 - Power Supply**

The auxiliary power is supplied by a built-in module fully isolated and self protected.

Two options are available:

- a) - { 24V(-20%) / 110V(+15%) a.c.  
24V(-20%) / 125V(+20%) d.c.
- b) - { 80V(-20%) / 220V(+15%) a.c.  
90V(-20%) / 250V(+20%) d.c.

Before energising the unit check that supply voltage is within the allowed limits.

## 2.2 - Operation and Algorithms

### 2.2.1 - Reference Input Values

Display			Description	Setting Range	Step	Unit
I1	100	A	Rated Primary current of phase C.T.	1 - 9999	1	A
I2	1	A	Rated Secondary current of phase C.T.	1 - 5	1/5	A
Io1	100	A	Rated Primary current of the core C.T. detecting earth fault current.	1 - 9999	1	A
Io2	1	A	Rated secondary current of the core C.T. detecting earth fault current.	1 - 5	1/5	A
In	100	A	Reference primary current of the relay	1 - 9999	1	A
Freq	50	Hz	System rated frequency	50 - 60	10	Hz

### 2.2.2 - Input quantities

#### 2.2.2.1 - Mains Frequency (Freq)

The relay can operate either in 50Hz or 60Hz systems.  
The rated Mains Frequency " Freq " must be set accordingly.

#### 2.2.2.2 - Phase Current inputs (I1)

The relay directly displays the r.m.s. value of the Phase Currents " IA ", " IB ", " IC " flowing in the Primary of the input Current Transformers and refers all its measurements to that value.

To make the relay properly working with any C.T., when programming the relay settings, input the value "I1" of the primary current of the phase C.Ts

Only phase A and C currents are measured, whereas the current of the phase B is computed as vector summation of the currents of the other two phases.

The algorithm is based on the following considerations coming from well-known vector relations among the three-phase currents and the zero sequence current.

- In any circumstance – currents balanced or not, sinusoidal or not – it is always true that:

$$(1) \quad \bar{I}_A + \bar{I}_B + \bar{I}_C + \bar{I}_0 = 0$$

- When no Earth Fault exists ( $I_0 = 0$ )

$$(2) \quad \bar{I}_A + \bar{I}_B + \bar{I}_C = 0 \Rightarrow \bar{I}_B = -(\bar{I}_A + \bar{I}_C)$$

The earth fault protection element is independently supplied by the residual current coming either from the residual connection of 3 system C.Ts. or from the core balance C.T.

If any Earth Fault is experienced ( $I_0 \neq 0$ ) the Earth Fault Protection Element trips independently from the phase current measuring elements.

If no Earth Fault is present ( $I_0 = 0$ ), the equation (2) is valid, no matter if currents are balanced or not, sinusoidal or not.

The third phase current is calculated, in real time, as vector summation of the other two-phase currents.

During Faults:

- A) Single phase to earth Fault Trip of the earth fault element directly measuring the Residual Current.
- B) Two Phase Fault In any case one of the currents directly measured is involved, so the relay trips correctly.
- C) Two Phase to Earth Fault Same as A + B
- D) Three Phase Fault All the three currents are correctly measured (in any case two directly).

### 2.2.2.3 - Earth Fault Current Input (I<sub>0n</sub>)

Same as for the Phase Currents, the relay directly displays the r.m.s. value of the Zero Sequence Residual Current flowing at the Primary of the Current Transformers.

If the input to the Earth Fault element is supplied by the residual connection of the 3 phase C.Ts., we shall set for the variable “I<sub>01</sub>” the same value as “I<sub>1</sub>”.

If the input to the Earth Fault element is supplied by a separated Core Balance C.T., or by another CT, “I<sub>01</sub>” value will be the Rated Primary Current of this C.T., normally different from “I<sub>1</sub>”.

### 2.2.2.4 - Algorithm of the time current curves

The Time Current Curves are generally calculated with the following equation :

$$(1) \quad t(I) = \left[ \frac{A}{\left(\frac{I}{I_s}\right)^{a^a} - 1} + B \right] \bullet K \bullet T_s + t_r$$

where :

t(I) = Actual trip time delay when the input current equals “I”

I = Maximum of the three input currents.

I<sub>s</sub> = Set minimum pick-up level

$$K = \left( \frac{A}{10^a - 1} \right)^{-1}$$

T<sub>s</sub> = Set time delay :  $t(I) = T_s$  when  $\frac{I}{I_s} = 10$

t<sub>r</sub> = Operation time of the output relay on pick-up.

The parameters “A” and “a” have different values for the different Time Current Curves.

Curve Name	Curve Identifier	A	B	a
IEC A Inverse	A	0.14	0	0.02
IEC B Very Inverse	B	13.5	0	1
IEC C Extremely Inverse	C	80	0	2
IEEE Moderate Inverse	MI	0.0104	0.0226	0.02
IEEE Short Inverse	SI	0.00342	0.00262	0.02
IEEE Very Inverse	VI	3.88	0.0963	2
IEEE Inverse	I	5.95	0.18	2
IEEE Extremely Inverse	EI	5.67	0.0352	2

**The maximum measuring current is “40xI<sub>n</sub>” for phase elements and “10xO<sub>n</sub>” for the neutral elements.**

2.2.3 - Time Current Curves IEC (TU1029 Rev.0)

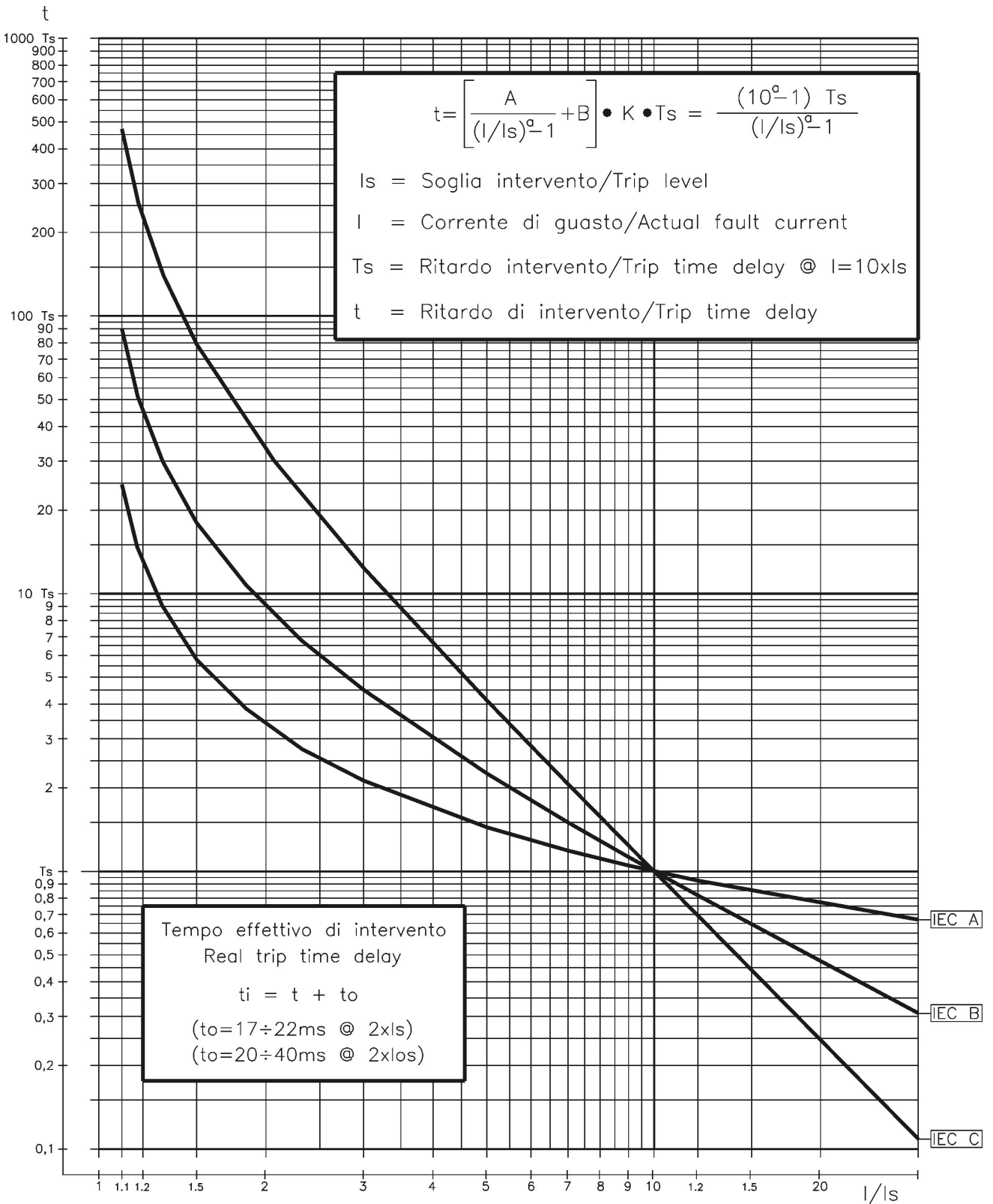

Curve Type	A	B	K	$\alpha$
IEC A	0.14	0	0.336632	0.02
IEC B	13.5	0	0.666667	1
IEC C	80	0	1.2375	2

Max. "I" Phase = 40xIn  
Max. "I" Neutral = 10xIn



2.2.4 - Time Current Curves IEEE (TU1028 Rev.0)

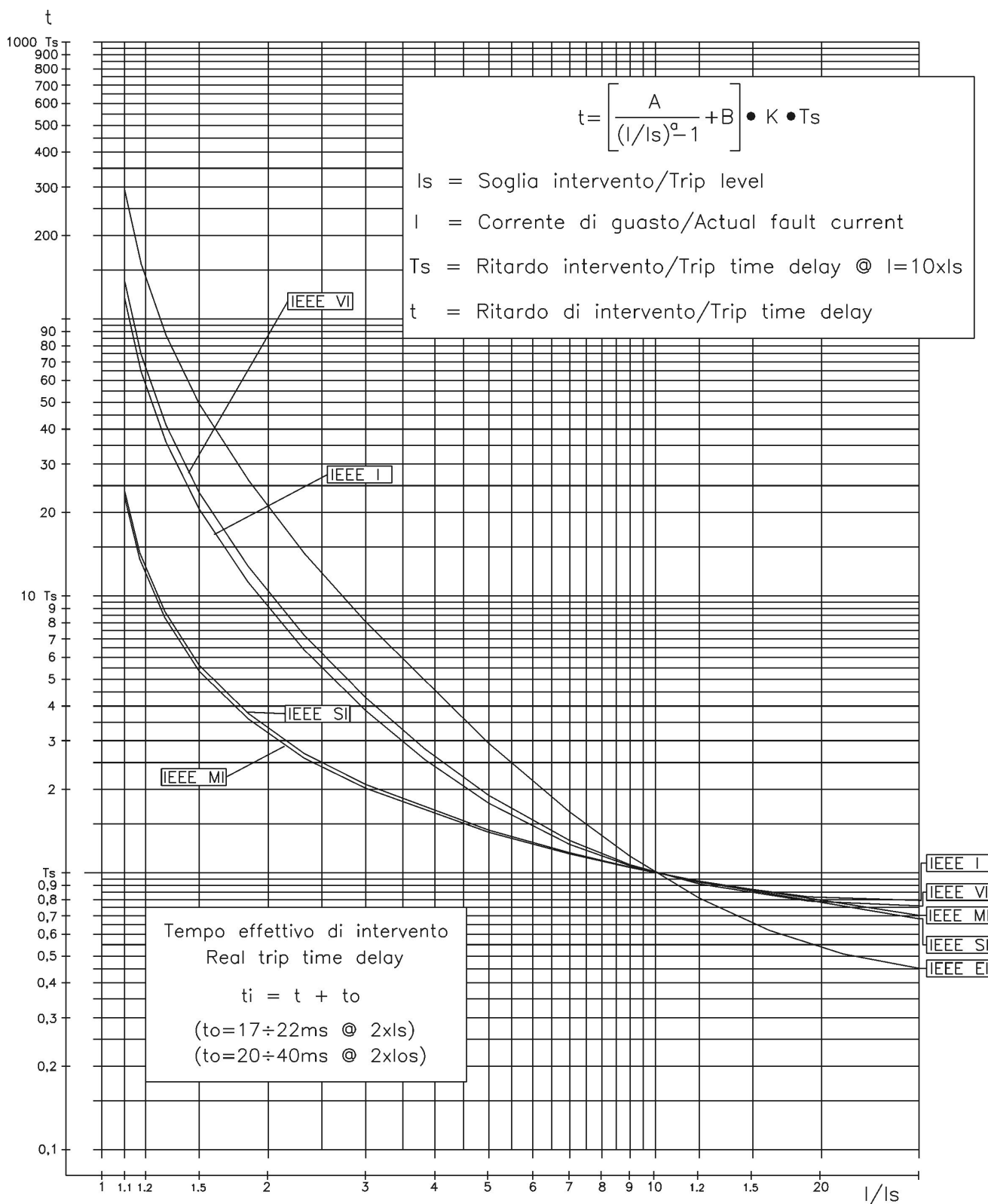

Curve Type	A	B	K	a
MI= IEEE Moderate Inv.	0.0104	0.0226	4.110608	0.02
SI= IEEE Short Inv.	0.00342	0.00262	13.30009	0.02
VI= IEEE Very Inv.	3.88	0.0963	7.380514	2
I= IEEE Inverse	5.95	0.18	4.164914	2
EI= IEEE Extremely Inv.	5.67	0.0352	10.814	2

Max. "I" Phase = 40xIn  
Max. "I" Neutral = 10xOn

2.2.5 - Functions and Settings (Function)

2.2.5.1 - I> (1F51) - First overcurrent protection level

<b>FuncEnab</b>	→	Enable		[Disable / Enable]
<b>Options</b>	→	<b>TCC</b>	D	[D / A / B / C / MI / VI / I / EI // SI]
	→	<b>BI</b>	Disable	[Disable / Enable]
	→	<b>Trg</b>	Enable	[Disable / Enable]
<b>TripLev</b>	→	<b>I&gt;</b>	0.5	<b>In</b> (0.10 ÷ 4.00) step 0.01 In
<b>Timers</b>	→	<b>tI&gt;</b>	2.00	<b>s</b> (0.05 ÷ 60.00) step 0.01 s

- FuncEnab** : If disable the function is deactivated

---

- TCC** : Time current curves
  - D** = Independent Definite Time
  - A** = IEC A Inverse
  - B** = IEC B Very Inverse
  - C** = IEC C Extremely Inverse
  - MI** = IEEE Moderate Inverse Curve
  - VI** = IEEE Very Inverse Curve
  - I** = IEEE Inverse Curve
  - EI** = IEEE Extremely Inverse Curve
  - SI** = IEEE Short Inverse Curve
- BI** : Operation controlled by Blocking Digital Input
- Trg** : Function operation triggers the oscillographic wave form capture (see § 2.2.3.12)

---

- I>** : Minimum phase current pick-up level (limited to 40 times In)

---

- tI>** : Trip time delay

2.2.5.2 - I>> (2F51) - Second overcurrent protection level

<b>FuncEnab</b>	→	Enable		[Disable / Enable]
<b>Options</b>	→	<b>BI</b>	Disable	[Disable / Enable]
	→	<b>2xI</b>	Disable	[Disable / Enable]
	→	<b>Trg</b>	Enable	[Disable / Enable]
<b>TripLev</b>	→	<b>I&gt;&gt;</b>	2.00	<b>In</b> (0.50 ÷ 40.00) step 0.01 In
<b>Timers</b>	→	<b>tI&gt;&gt;</b>	1.00	<b>s</b> (0.05 ÷ 60.00) step 0.01 s
	→	<b>t2xI</b>	0.10	<b>s</b> (0.02 ÷ 9.99) step 0.01 s

- FuncEnab** : If disable the function is deactivated

---

- BI** : Operation controlled by Blocking Digital Input
- 2xI** : Automatic threshold doubling on inrush
- Trg** : Function operation triggers the oscillographic wave form capture (see § 2.2.3.12)

---

- I>>** : Minimum phase current pick-up level (limited to 40 times In)

---

- tI>>** : Trip time delay
- t2xI** : Trip time delay

2.2.5.3 - **IH (3F51)** - Third overcurrent protection level

<b>FuncEnab</b>	→	Enable		[Disable / Enable]
<b>Options</b>	→	<b>BI</b>	Disable	[Disable / Enable]
	→	<b>2xI</b>	Enable	[Disable / Enable]
	→	<b>Trg</b>	Enable	[Disable / Enable]
<b>TripLev</b>	→	<b>IH</b>	5.00	<b>In</b> (0.50 ÷ 40.00) step 0.01 In
<b>Timers</b>	→	<b>tIH</b>	0.05	<b>s</b> (0.05 ÷ 60.00) step 0.01 s
	→	<b>t2xI</b>	0.10	<b>s</b> (0.02 ÷ 9.99) step 0.01 s

- FuncEnab** : If disable the function is deactivated

---

- BI** : Operation controlled by Blocking Digital Input
- 2xI** : Automatic threshold doubling on inrush
- Trg** : Function operation triggers the oscillographic wave form capture (see § 2.2.3.12)

---

- IH** : Minimum phase current pick-up level (limited to 40 times In)

---

- t2xI** : Trip time delay
- tIH** : Trip time delay

2.2.5.3.1 – Automatic doubling or Overcurrent thresholds on current inrush

For some of the phase Overcurrent functions it is possible to have the set trip level [Is] automatically doubled when strong inrush current is detected.

If at circuit Breaker switch-on (i.e. when the input current rises from zero to a minimum measurable value) the current increases from 0 to 1.5 times the rated value [In] in less than 60ms, the set minimum pick-up level [Is] is dynamically doubled ([Is]→[2Is]) and keeps this value until the input current drops below 1.25xIn or the set time [t2xI] has elapsed.

This functionality is very useful to avoid spurious tripping of the instantaneous or short-time delayed Overcurrent elements that could be experienced at switch-on of reactive loads like Transformer or Capacitors.

2.2.5.5 - **Io>** (1F51N) - First Earth Fault protection level

<b>FuncEnab</b>	→	Enable		[Disable / Enable]
<b>Options</b>	→	<b>TCC</b>	D	[D / A / B / C / I / VI / EI / MI / SI]
	→	<b>BI</b>	Disable	[Disable / Enable]
	→	<b>Trg</b>	Enable	[Disable / Enable]
<b>TripLev</b>	→	<b>Io&gt;</b>	0.10	<b>Ion</b> (0.01 ÷ 4.00) step 0.01 Ion
<b>Timers</b>	→	<b>tIo&gt;</b>	2.00	<b>s</b> (0.05 ÷ 60.00) step 0.01 s

- **FuncEnab** : If disable the function is deactivated

---

- **TCC** : Time current curves
  - D** = Independent Definite Time
  - A** = IEC A Inverse
  - B** = IEC B Very Inverse
  - C** = IEC C Extremely Inverse
  - MI** = IEEE Moderate Inverse Curve
  - VI** = IEEE Very Inverse Curve
  - I** = IEEE Inverse Curve
  - EI** = IEEE Extremely Inverse Curve
  - SI** = IEEE Short Inverse Curve
- **BI** : Operation controlled by Blocking Digital Input
- **Trg** : Function operation triggers the oscillographic wave form capture (see § 2.2.3.12)

---

- **Io>** : Minimum Zero Sequence Residual Current Pick-up level

---

- **tIo>** : Trip time delay

2.2.5.6 - **Io>>** (2F51N) - Second Earth Fault protection level

<b>FuncEnab</b>	→	Enable		[Disable / Enable]
<b>Options</b>	→	<b>BI</b>	Disable	[Disable / Enable]
	→	<b>Trg</b>	Enable	[Disable / Enable]
<b>TripLev</b>	→	<b>Io&gt;&gt;</b>	0.50	<b>Ion</b> (0.01 ÷ 9.99) step 0.01 Ion
<b>Timers</b>	→	<b>tIo&gt;&gt;</b>	1.00	<b>s</b> (0.05 ÷ 60.00) step 0.01 s

- **FuncEnab** : If disable the function is deactivated

---

- **BI** : Operation controlled by Blocking Digital Input
- **Trg** : Function operation triggers the oscillographic wave form capture (see § 2.2.3.12)

---

- **Io>>** : Minimum Zero Sequence Residual Current Pick-up level

---

- **tIo>>** : Trip time delay

2.2.5.7 - **IoH (3F51N)** - Third Earth Fault protection level

<b>FuncEnab</b>	→	Enable	[Disable / Enable]
<b>Options</b>	→	<b>BI</b>	Disable [Disable / Enable]
	→	<b>Trg</b>	Enable [Disable / Enable]
<b>TripLev</b>	→	<b>IoH</b>	2.00 <b>Ion</b> (0.01 ÷ 9.99) step 0.01 Ion
<b>Timers</b>	→	<b>tIoH</b>	0.10 <b>s</b> (0.05 ÷ 60.00) step 0.01 s

- FuncEnab** : If disable the function is deactivated

---

- BI** : Operation controlled by Blocking Digital Input
- Trg** : Function operation triggers the oscillographic wave form capture (see § 2.2.3.12)

---

- IoH** : Minimum Zero Sequence Residual Current Pick-up level

---

- tIoH** : Trip time delay

2.2.5.8 - **BF (F51BF)** - Breaker Failure

<b>FuncEnab</b>	→	Enable	[Disable / Enable]
<b>Options</b>	→	<b>TrR</b>	Relay1 – Relay2 – Relay3 – Relay4
<b>TripLev</b>	→	No Param	No Parameters
<b>Timers</b>	→	<b>tBF</b>	0.20 <b>s</b> (0.05 ÷ 0.75) step 0.01 s

- FuncEnab** : If disable the function is deactivated

---

- TrR** : Output relay programmed for trip command to the Circuit Breaker

---

- tBF** : Trip time delay
  
- Operation: If after the time “tBF” from pick-up of the programmed relay “TrR” the current measured still exceeds 5%In, the output relay associated to the “BF” function is operated (relay another than TrR).

2.2.5.9 - **RTD** - Remote Trip

Remote trip is controlled via the Digital Input D2.

<b>FuncEnab</b>	→	Disable	[Disable / Enable]
<b>Options</b>	→	No Param	No Parameters
<b>TripLev</b>	→	No Param	No Parameters
<b>Timers</b>	→	No Param	No Parameters

- FuncEnab** : If disable the function is deactivated

2.2.5.10 - **I.R.F.** - Internal Relay Failure

<b>FuncEnab</b>	→	No Param	No Parameters
<b>Options</b>	→	<b>Opl</b> NoTrip	[NoTrip / Trip]
<b>TripLev</b>	→	No Param	No Parameters
<b>Timers</b>	→	No Param	No Parameters

- **Opl** : The variable “ Opl “ can be programmed to trip the output relays same as the other protection functions (Opl = TRIP), or to only operate the “ IRF “ signal led without tripping the output relays (Opl = NoTRIP).

2.2.5.11 - **Osc** - Oscillographic Recording

<b>FuncEnab</b>	→	Enable	[Disable / Enable]
<b>Options</b>	→	<b>Trg</b> Trip	[Disable / Start / Trip / Ext.Inp.]
<b>TripLev</b>	→	No Param	No Parameters
<b>Timers</b>	→	<b>tPre</b> 0.30	s (0.10 ÷ 0.50) step 0.1 s
	→	<b>tPost</b> 0.30	s (0.10 ÷ 1.50) step 0.1 s

- **FuncEnab** : If disable the function is deactivated
- **Trg** : *Disab* = Function Disable (no recording)  
*Start.* = Trigger on time start of protection functions  
*Trip* = Trigger on trip (time delay end) of protection functions  
*Ext.Inp.* = Trigger from the Digital Input D3
- **tPre** : Recording time before Trigger
- **tPost** : Recording time after Trigger

When the option “Start” or “Trip” is selected:

The oscillographic recording is started respectively by the “Time Start” or by the “Time End” of any of the functions that have been programmed to Trigger the Wave Form Capture (I>, I>>, IH, Io>, Io>>, IoH).

The “Osc” Function includes the wave Form Capture of the input quantities (IA, IB, IC, Io) and can totally store a record of 3 seconds.

The number of events recorded depends on the duration of each individual recording (tPre + tPost). In any case the number of event stored can not exceed ten (10 x 0.3 sec). Any new event beyond the 3 sec capacity of the memory, cancel and overwrites the former records (FIFO Memory).

2.2.5.12 - **Comm** – Communication Parameters

<b>FuncEnab</b>	→	No Param	No Parameters
<b>Options</b>	→	<b>Com LBd</b> 9600	[9600 / 19200 / 38400 / 57600]
	→	<b>Com RBd</b> 9600	[9600 / 19200]
	→	<b>Com Mod</b> 8,n,1	[8,n,1 / 8,o,1 / 8,e,1]
	→	<b>Com RPd</b> Modbus	[Iec103 / Modbus]
<b>TripLev</b>	→	No Param	No Parameters
<b>Timers</b>	→	No Param	No Parameters

- Com LBd** : Local Baud Rate (Front panel RS232 communication speed)
- Com RBd** : Remote Baud Rate  
(Rear panel terminal blocks RS485 communication speed)
- Com Mod** : Remote mode (communication parameters)  
**Note:** Any change of this setting becomes valid at the next power on
- Com RPr** : Remote Protocol

2.2.5.13 - **LCD** – Display and Buzzer operation

<b>FuncEnab</b>	→	No Param	No Parameters
<b>Options</b>	→	<b>Key</b> BeepON	[BeepOFF / BeepON]
	→	<b>LCD</b> Auto	[Auto / On]
<b>TripLev</b>	→	No Param	No Parameters
<b>Timers</b>	→	No Param	No Parameters

- Key** : Buzzer “Beep” on operation of Keyboard buttons.
- LCD** : LCD Backlight continuously “ON” or switched-on Automatically on operation of Keyboard buttons.

---

### 3. Logic Blocking of Functions

---

#### 3.1 - Blocking output

---

The instantaneous element of each of the protection functions (1F50, 2F50, 3F50, 1F50N, 2F50N, 3F50N) can be programmed to control one of the Output Relays.

This relay picks-up as soon as the input quantity exceeds the set trip level of the Protection Function and it automatically resets when the input quantity drops below the function reset level ( $\approx 95\%$  of the trip level) or, in any case as soon as the time delay (tBF) of the Breaker Failure function is expired.

This instantaneous output can be used to activate the Blocking Input of another Protection Relay to implement a logic selectivity systems. As above explained, in case of Breaker Failure, the blocking output is released and the back-up protection enabled.

#### 3.2 – Blocking Input

---

The time delayed tripping of any of the Protection functions (1F51, 2F51, 3F51, 1F51N, 2F51N, 3F51N) can be controlled by the activation of the Digital Input D1 (BI=Enable): in this case the set trip time delay of the function is increased by “2xtBF” so that other Protection Relays (set with the same trip time delay) that send the activation signal to the blocking Input D2, can trip before open and the C/B nearest to the Fault.

Also in this case, however, another “2xtBF” seconds from the expiry of the set trip time delay, the blocking input is disregarded so allowing the protection relay to trip in case of Failure to open of the upstream Circuit Breaker.

### 4. Output Relays

---

Three user programmable Output Relays are normally available on main relay R1, R2, R3, by a Field Bus output (CANBUS) that controls additional number of user programmable Output Relays 1.R1, 1.R2, 1.R3, 1.R4.

Each of them can be programmed to be controlled by any element (instantaneous or time delayed) of any of the Relay Functions including Remote trip and Internal Relay Fault.

Moreover, the operation of each of the output relays can be programmed to be either Normally Deenergized (energized on tripping of the controlling Functional Element) or Normally Energized (Deenergized on tripping of the controlling Functional Element).



## 5. Digital Inputs

The firmware can manage up to 13 digital inputs and 7 output relays; among these, 3 digital inputs and 3 output relays are available on the relay module, the remaining are available on additional expansion (UX10-4) modules controlled via the CAN-Bus communication channel.

A Digital Input is activated when its terminals are shorted by a cold contact.

### Available in the Main relay

<b>D1</b>	Digital Input "D1" (terminals 22 - 19)	It is usable as Function Blocking Input.
<b>D2</b>	Digital Input "D2" (terminals 22 - 21)	It is used for Remote Trip.
<b>D3</b>	Digital Input "D3" (terminals 22 - 20)	The digital Input indicates the position of the Circuit Breaker (Input Closed = C/B closed; Input Open = C/B open). If the option External Trigger = Enabled any time the DI passed from closed to open the oscillographic recording is started.

### (UX10-4) Additional Expansion Module

<b>D1</b>	Digital Input "1.D1"	By the interface program "MSCom 2" it is possible view the status or via RS485 port (Modbus protocol).
<b>D2</b>	Digital Input "1.D2"	
<b>D3</b>	Digital Input "1.D3"	
<b>D4</b>	Digital Input "1.D4"	
<b>D5</b>	Digital Input "1.D5"	
<b>D6</b>	Digital Input "1.D6"	
<b>D7</b>	Digital Input "1.D7"	
<b>D8</b>	Digital Input "1.D8"	
<b>D9</b>	Digital Input "1.D9"	
<b>D10</b>	Digital Input "1.D10"	

## 6. Self-diagnostic

The relay incorporates a sophisticated self-diagnostic feature that continuously checks the following elements:

- A/D conversion
- Checksum of the settings stored into E<sup>2</sup>Prom.
- DSP general operation (Power, Routines, etc.)
- Lamp test (only on manual test).

Any time Power is switched on, a complete test is run; then, during normal operation, the test runs continuously and the checksum is done any time a parameter is stored into E<sup>2</sup>Prom.

If during the test any Relay Internal Failure (I.R.F) is detected:

If " I.R.F. " is programmed to " Trip ", the programmed output relays are operated same as on tripping of any protection function operation is stored in the " Event Records " and the I.R.F. signal led is set to flashing.

If " I.R.F. " is programmed to "NO Trip", and only the I.R.F. signal led is set to flashing.

## 7. Relay Management

The relay can be totally managed locally, either by the RS232 communication port or by the 4 key buttons and the LCD display, or remotely via the communication bus RS485 connected to the rear terminal blocks. The 2 line x 8 characters LCD display shows the available information. Key buttons operate according to the flow-chart herebelow.

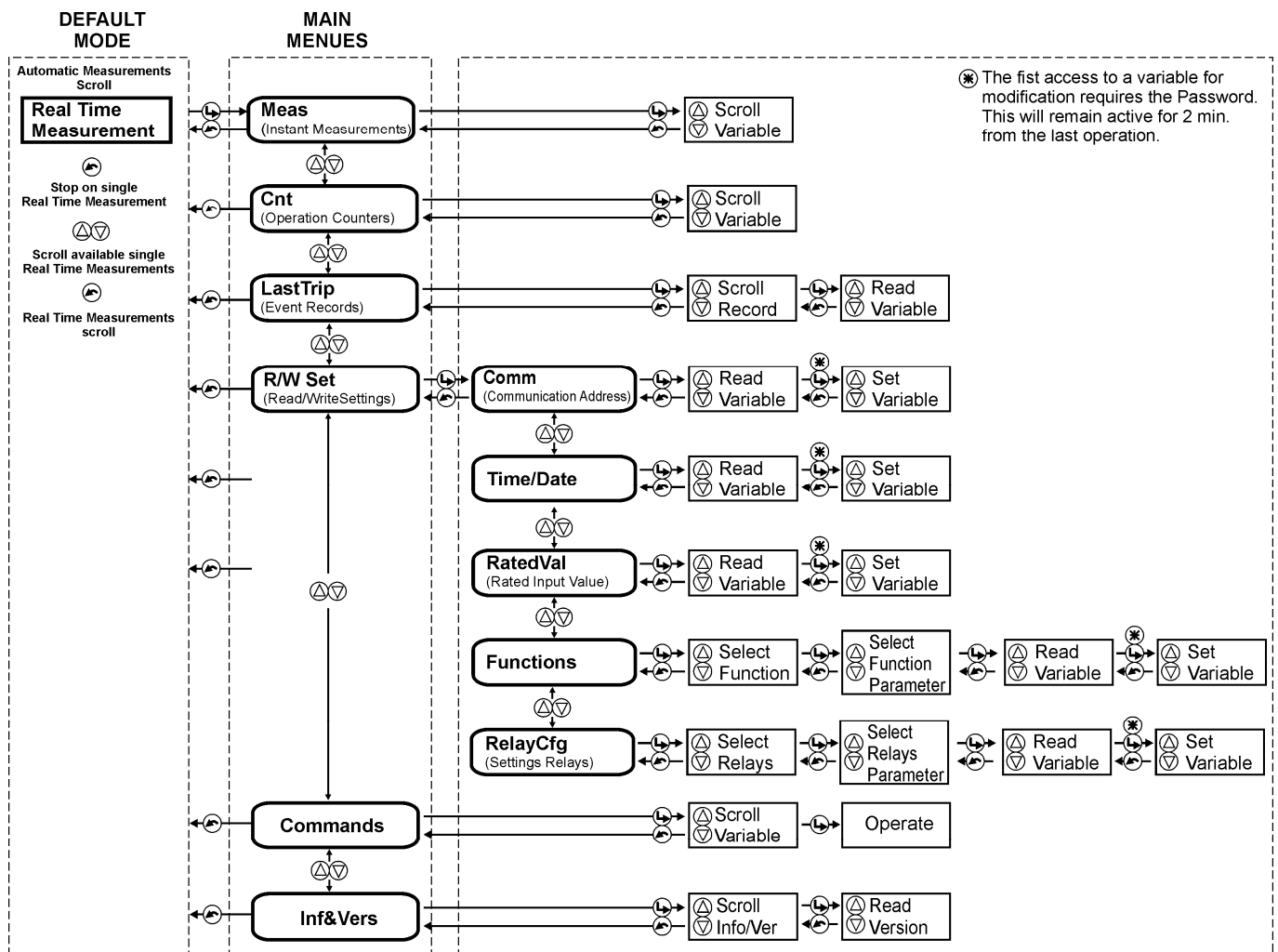

**8. Signalizations**

Four signal leds are available on the Front Face Panel:

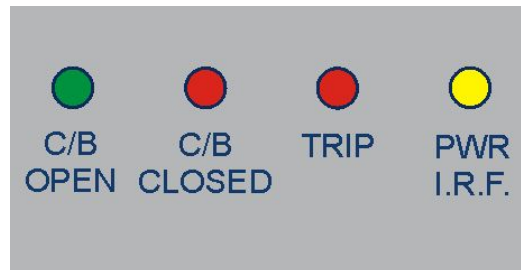

a)	Green LED	<b>C/B OPEN</b>	<input type="checkbox"/> Illuminated when C/B open status is detected. (Digital Input D3 Open)
b)	Red LED	<b>C/B CLOSED</b>	<input type="checkbox"/> Illuminated when C/B close status is detected. (Digital Input D3 closed) <input type="checkbox"/> Flashing when Breaker Failure is detected.
c)	Red LED	<b>TRIP (*)</b>	<input type="checkbox"/> Flashing when a timed function starts to operate. <input type="checkbox"/> Illuminated when any function is tripped; reset takes places by pressing the reset button.
d)	Yellow LED	<b>PWR/ I.R.F.</b>	<input type="checkbox"/> Illuminated during normal operation when Power Supply is ON. <input type="checkbox"/> Flashing when a Relay Internal Fault is detected.

(\*) When any protection function is tripped besides the Led which gives the general trip indication. The display shows the function that caused the tripping:

LastTrip "Cause"      steady blinking

**9. Keyboard Buttons**

	<b>Enter</b>	Give access to any menu or convalidate any programming changement.  This button is besides used for the control of Open/Close C/B (see § Command).
	<b>Reset</b>	Return from the actual selected menu to the former menu.
	<b>Select +</b>	Scrolls variables available in the different menus or increases/decreases setting values.
	<b>Select -</b>	

## 10. Serial Communication Port

### 10.1 - Main RS485 Serial Communication Port

This port is accessible via the terminals 1-2-3 provided on the relay terminal board.

It is used for connection to a serial bus interfacing up to 31 units with the Central Supervision System (SCADA, DCS, ecc).

The serial bus is a shielded pair of twisted cables connecting in parallel (Multi Drop) the different units (slaves) by the relevant terminals.

The physical link is RS485 and the Communication Protocol is MODBUS/RTU / IEC60870-5-103.

The configuration of transmission parameters is selectable.

<input type="checkbox"/>	Baud Rate	:	9600/19200 bps	9600/19200 bps	9600/19200 bps
<input type="checkbox"/>	Start bit	:	1	1	1
<input type="checkbox"/>	Data bit	:	8	8	8
<input type="checkbox"/>	Parity	:	None	Odd	Even
<input type="checkbox"/>	Stop bit	:	1	1	1

**Note:** any change of this setting becomes valid at the next power on.

Each relay is identified by its programmable address code (NodeAd) and can be called from the P.C.

A dedicated communication software (MSCom) for windows 95/98/NT4 SP3 (or later) is available.

Please refer to the MSCom instruction manual for more information.

Maximum length of the serial bus can be up to 200m.

### CONNECTION TO RS485

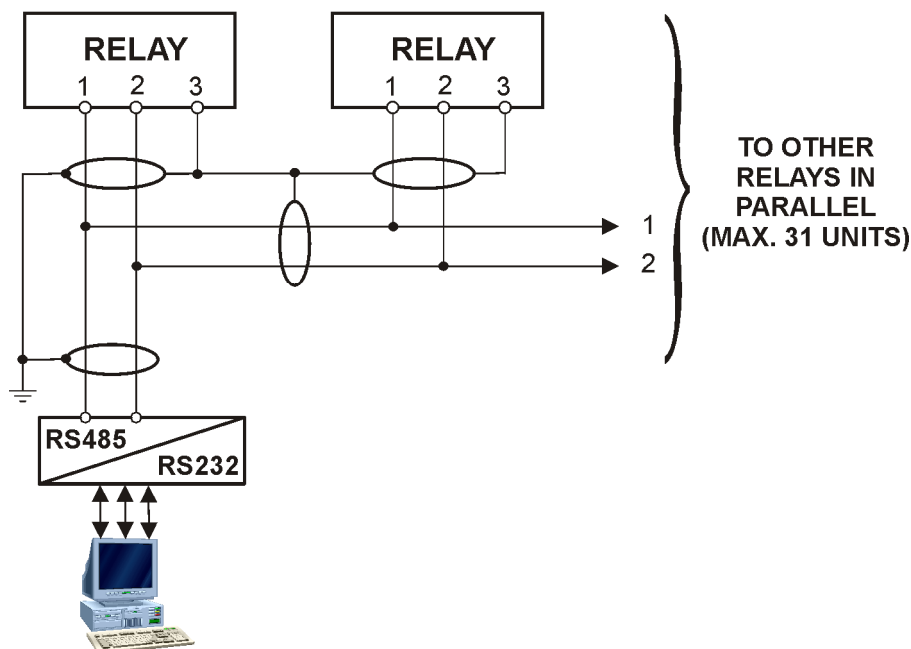

For longer distance and for connection of up to 250 Relays, optical interconnection is recommend.  
(please ask Microelettrica for accessories)

**10.2 - Communication Port on Front Face Panel**



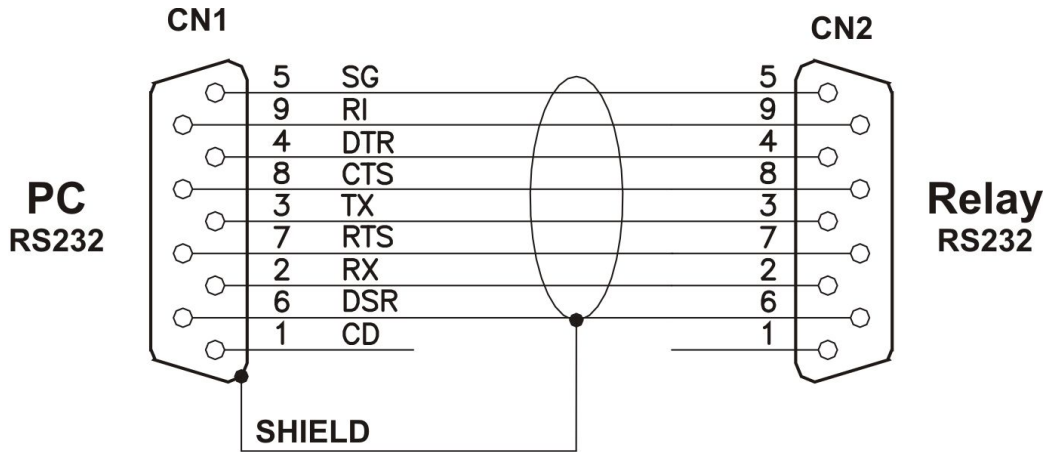

This port is used for communication through the Front Face Panel between a local Lap-top PC.

The physical link is RS232 by the standard female 9-pin D-sub connector available on the Front Face Panel. Via this Port complete Relay management and data acquisition is possible.



11. Menu and Variables

11.1 - Real Time Measurements

Scrolling display of the Real Time Measurements is the Default operation. Scrolling can be stopped at any of the measurements and restarted by pressing the Reset button . When stopped on one variable,  appears aside the measurement and the different available measurements can be selected by the   buttons.

Display			Description
<b>I</b>	= 0 – 65535	<b>%In</b>	Largest of the 3 phase-currents (% of rated current)
<b>IA</b>	= 0 – 65535	<b>A</b>	RMS value of Phase A current
<b>IB</b>	= 0 – 65535	<b>A</b>	RMS value of Phase B current
<b>IC</b>	= 0 – 65535	<b>A</b>	RMS value of Phase C current
<b>Io</b>	= 0.0 – 6553.5	<b>A</b>	RMS value of Zero Sequence Current (RMS Primary Amps)

11.2 - Meas (Instantaneous Measurements)





Real time measurements can be frozen at any moment selecting the menu “ Instant Measure “:

- “ Real Time Meas “ 
- “ Meas “ 
- “ 1<sup>st</sup> Measurement   other measurements
-  to go back to “ Meas “

Display			Description
<b>I</b>	= 0 – 65535	<b>%In</b>	Largest of the 3 phase-currents (% of rated current)
<b>IA</b>	= 0 – 65535	<b>A</b>	RMS value of Phase A current (Primary Amps)
<b>IB</b>	= 0 – 65535	<b>A</b>	RMS value of Phase B current (Primary Amps)
<b>IC</b>	= 0 – 65535	<b>A</b>	RMS value of Phase C current (Primary Amps)
<b>Io</b>	= 0.0 – 6553.5	<b>A</b>	RMS value of Zero Sequence Current (Primary Amps)

11.3 - Counter (Operation Counters)

The operation of any of the function herebelow reported, is counted and recorded in the menu “Counters “.







- “ Real Time Meas “ 
- “Counter “ 
- “ 1<sup>st</sup> counters   other counters
-  to go back to “Counter “

Display			Description
<b>I&gt;</b>	=	0 – 65535	Number of 1 <sup>st</sup> Overcurrent (time delayed) trip
<b>I&gt;&gt;</b>	=	0 – 65535	Number of 2 <sup>nd</sup> Overcurrent (time delayed) trip
<b>IH</b>	=	0 – 65535	Number of 3 <sup>rd</sup> Overcurrent (time delayed) trip
<b>Io&gt;</b>	=	0 – 65535	Number of 1 <sup>st</sup> time delayed Earth Fault trip
<b>Io&gt;&gt;</b>	=	0 – 65535	Number of 2 <sup>nd</sup> time delayed Earth Fault trip
<b>IoH</b>	=	0 – 65535	Number of 3 <sup>rd</sup> time delayed Earth Fault trip
<b>BF</b>	=	0 – 65535	Number of operation of Breaker Failure
<b>RTD</b>	=	0 – 65535	Number of External Trip commands
<b>I.R.F.</b>	=	0 – 65535	Number of Internal Relay Faults
<b>HR</b>	=	0 – 65535	Number of HW recovery operations



**11.4 - LastTrip (Event Recording)**

The MC20 records any tripping and stores the information relevant to the last 20 tripping of protection functions (FIFO).

Each event recording includes the following information.

- " Real Time Meas " 
- " LastTrip " 
-  1<sup>st</sup> event,
-  to scroll available events,
-  to " Rec # " selected,
-  to select the different fields;

Display	Description
<b>Func</b> xxxxx	Indication of the protection function which caused the relay tripping. For indication of the TRIP Cause the following acronyms are used:
	<ul style="list-style-type: none"> <li>- I&gt;                    = 1<sup>st</sup> Overcurrent (Short Circuit)</li> <li>- I&gt;&gt;                  = 2<sup>nd</sup> Overcurrent (Short Circuit)</li> <li>- IH                    = 3<sup>rd</sup> Overcurrent (Short Circuit)</li> <li>- Io&gt;                  = 1<sup>st</sup> Earth Fault</li> <li>- Io&gt;&gt;                 = 2<sup>nd</sup> Earth Fault</li> <li>- IoH                  = 3<sup>rd</sup> Earth Fault</li> <li>- RTD                 = External Trip commands</li> <li>- IRF                  = Internal Relay Fault</li> </ul>
<b>Date</b> : YYYY/MM/GG	Date: Year/Month/Day
<b>Time</b> : hh:mm:ss:cc	Time: hours/minutes/second/hundredths of seconds
<b>IA</b> = 0 – 65535 <b>A</b>	RMS value of phase A current (Primary Amps)
<b>IB</b> = 0 – 65535 <b>A</b>	RMS value of phase B current (Primary Amps)
<b>IC</b> = 0 – 65535 <b>A</b>	RMS value of phase C current (Primary Amps)
<b>Io</b> = 0.0 – 6553.5 <b>A</b>	RMS value of Zero Sequence Current (Primary Amps)

-  to go back to " Rec # ",
-  to go back to " Real Time Meas ".

**11.5 - R/W Set (Programming / Reading the Relay Settings)**

- “ Main Menu “
- select “ Function “
- select among following sub menus:

**11.5.1 - CommAdd (Communication Address)**

- “ Common “
- “ Add: # “
- “ Password ????? “ (if not yet entered; see § Password)
- to select the Address (1-250)
- to validate. Set Done!

The default address is 1.

Display	Description	Setting Range	Step	Unit
<b>Add:</b> 1	Identification number for connection on serial communication bus	1 - 250	1	-

**11.5.2 - Time/Date (Time/Date)**

- “ Time/Date “ Date: Current Date, Time: Current time
- “ YY/..... “ to set year,
- “ XX/MM “ to set month,
- “ XX/XX/DD “ to set day,
- “ XX/XX/XX “
- “ hh/mm “ to set hour,
- “ XX/mm “ to set minutes,
- To validate Set Done!
- Exit

**11.5.3 - RatedVal (Rated Input Values)**

- “RatedVal “
- 1<sup>st</sup> Variable
- to scroll variables
- to modify selected variable
- “ Password ????? “ (if not yet entered) or #??? (if not yet entered; see § Password)
- to set variable value,
- to validate. Set Done!

Display	Description	Setting Range	Step	Unit
<b>I1</b> 100 A	Rated Primary current of phase C.T.	1 - 9999	1	A
<b>I2</b> 1 A	Rated Secondary current of phase C.T.	1 - 5	1/5	A
<b>Io1</b> 100 A	Rated Primary current of the tore C.T. detecting earth fault current.	1 - 9999	1	A
<b>Io2</b> 1 A	Rated secondary current of the tore C.T. detecting earth fault current.	1 - 5	1/5	A
<b>In</b> 100 A	Reference primary current of the relay	1 - 9999	1	A
<b>Freq</b> 50 Hz	System rated frequency	50 - 60	10	Hz



11.5.4 - Function (Functions)

- “ Function “,
  - 1<sup>st</sup> function,
  - to scroll available Functions,
  - to Read/Write setting of the selected function,
  - to select the different definable fields
  - to access the selected field and read the actual setting of the relevant variable
  - to modify the actual setting;
  - to set the new value.
  - to validate.
- FuncEnab                      - TripLev  
- Options                        - Timers
- Set Done!

Function	Display				Description	Setting Range	Step
	Type	Variable	Default Setting	Unit			
<b>Password</b>	=	0000-9999	1111	-	Password for programming enable (see § Password)		
<b>I&gt;</b> (1F51)	<b>FuncEnab</b>	→		Enable	Enable of the protection function	Enable/Disable	-
	<b>Options</b>	→	<b>TCC</b>	D	Time Current Curves	D,A,B,C, I, VI, EI, MI, SI	-
			<b>BI</b>	Disable	Operation controlled by Blocking Digital Input	Enable/Disable	-
			<b>Trg</b>	Enable	Function operation triggers the oscillographic wave form capture	Enable/Disable	-
	<b>TripLev</b>	→	<b>I&gt;</b>	0.50	In	Trip level of overcurrent protection	0.10 – 4.00
<b>Timers</b>	→	<b>tI&gt;</b>	2.00	s	Trip time delay	0.05 – 60.00	0.01
<b>I&gt;&gt;</b> (2F51)	<b>FuncEnab</b>	→		Enable	Enable of the protection function	Enable/Disable	-
	<b>Options</b>	→	<b>BI</b>	Disable	Operation controlled by Blocking Digital Input	Enable/Disable	-
			<b>2xI</b>	Disable	Automatic threshold doubling on inrush	Enable/Disable	-
			<b>Trg</b>	Enable	Function operation triggers the oscillographic wave form capture	Enable/Disable	-
	<b>TripLev</b>	→	<b>I&gt;&gt;</b>	2.00	In	Trip level of overcurrent protection	0.50 – 40.00
<b>Timers</b>	→	<b>tI&gt;&gt;</b>	1.00	s	Trip time delay	0.05 – 60.00	0.01
		<b>t2xI</b>	0.10	s	Trip time delay Automatic threshold doubling	0.02 – 9.99	0.01
<b>IH</b> (3F51)	<b>FuncEnab</b>	→		Enable	Enable of the protection function	Enable/Disable	-
	<b>Options</b>	→	<b>BI</b>	Disable	Operation controlled by Blocking Digital Input	Enable/Disable	-
			<b>2xI</b>	Enable	Automatic threshold doubling on inrush	Enable/Disable	-
			<b>Trg</b>	Enable	Function operation triggers the oscillographic wave form capture	Enable/Disable	-
	<b>TripLev</b>	→	<b>IH</b>	0.50	In	Trip level of overcurrent protection	0.50 – 40.00
<b>Timers</b>	→	<b>tIH</b>	0.05	s	Trip time delay	0.05 – 60.00	0.01
		<b>t2xI</b>	0.10	s	Trip time delay Automatic threshold doubling	0.02 – 9.99	0.01
<b>Io&gt;</b> (1F51N)	<b>FuncEnab</b>	→		Enable	Enable of the protection function	Enable/Disable	-
	<b>Options</b>	→	<b>TCC</b>	D	Time Current Curves	D,A,B,C, I, VI, EI, MI, SI	-
			<b>BI</b>	Disable	Operation controlled by Blocking Digital Input	Enable/Disable	-
			<b>Trg</b>	Enable	Function operation triggers the oscillographic wave form capture	Enable/Disable	-
	<b>TripLev</b>	→	<b>Io&gt;</b>	0.10	Ion	Trip level of Earth Fault protection	0.01 – 4.00
<b>Timers</b>	→	<b>tIo&gt;</b>	2.00	s	Trip time delay	0.05 – 60.00	0.01
<b>Io&gt;&gt;</b> (2F51N)	<b>FuncEnab</b>	→		Enable	Enable of the protection function	Enable/Disable	-
	<b>Options</b>	→	<b>BI</b>	Disable	Operation controlled by Blocking Digital Input	Enable/Disable	-
			<b>Trg</b>	Enable	Function operation triggers the oscillographic wave form capture	Enable/Disable	-
	<b>TripLev</b>	→	<b>Io&gt;&gt;</b>	0.50	Ion	Trip level of Earth Fault protection	0.01 – 9.99
<b>Timers</b>	→	<b>tIo&gt;&gt;</b>	1.00	s	Trip time delay	0.05 – 60.00	0.01
<b>IoH</b> (3F51N)	<b>FuncEnab</b>	→		Enable	Enable of the protection function	Enable/Disable	-
	<b>Options</b>	→	<b>BI</b>	Disable	Operation controlled by Blocking Digital Input	Enable/Disable	-
			<b>Trg</b>	Enable	Function operation triggers the oscillographic wave form capture	Enable/Disable	-
	<b>TripLev</b>	→	<b>IoH</b>	2.00	Ion	Trip level of Earth Fault protection	0.01 – 9.99
<b>Timers</b>	→	<b>tIoH</b>	0.10	s	Trip time delay	0.05 – 60.00	0.01

Function	Display				Description	Setting Range	Step	
	Type	Variable	Default Value	Unit				
BF (F51BF)	FuncEnab	→		Enable	Enable of the protection function	Enable/Disable	-	
	Options	→	TrR	Relay1	Output relay operated on BF tripping	Relay1- Relay2 Relay3- Relay4	-	
	TripLev	→	No Parameters					
	Timers	→	tBF	0.20	s	Time delay for Breaker Failure alarm	0.05 – 0.75	0.01
RTD	FuncEnab	→		Disable	Enable of the protection function	Enable/Disable	-	
	Options	→	No Parameters					
	TripLev	→	No Parameters					
	Timers	→	No Parameters					
IRF	FuncEnab	→		Enable	Enable of the protection function	Enable/Disable	-	
	Options	→	Opl	NoTrip	Operation of output Relays on detection of Internal Relay Fault	NoTrip – Trip	-	
	TripLev	→	No Parameters					
	Timers	→	No Parameters					
Osc	FuncEnab	→		Enable	Enable of the protection function	Enable/Disable	-	
	Options	→	Trg	Trip	Trigger operation mode	Disable Start Trip Ext.Inp	-	
	TripLev	→	No Parameters					
	Timers	→	tPre	0.30		Recording time before Trigger	0.10 – 0.50	0.1
		→	tPost	0.30		Recording time after Trigger	0.10 – 1.50	0.1
Comm	FuncEnab	→	No Parameters					
	Options	→	Com LBd	9600	Local Baud Rate (Front panel RS232 communication speed)	9600 / 19200 / 38400 / 57600	-	
		→	Com RBd	9600	Remote Baud Rate (Rear panel terminal blocks RS485 communication speed)	9600 / 19200	-	
		→	Com Mod	8,n,1	Remote mode (communication parameters) <i>Note: any change of this setting became valid at the next power on</i>	8,n,1 8,o,1 8,e,1	-	
		→	Com RPr	IEC103	Remote Protocol	IEC103- Modbus	-	
	TripLev	→	No Parameters					
Timers	→	No Parameters						
LCD	FuncEnab	→	No Parameters					
	Options	→	Key	BeepON	Buzzer "Beep" on operation of Keyboard buttons.	BeepON- BeepOFF	-	
		→	BkL	ON	LCD Backlight continuously "ON" or switched-on Automatically on operation of Keyboard buttons.	ON - OFF	-	
	TripLev	→	No Parameters					
Timers	→	No Parameters						

Settings can also be programmed via the serial communication ports.

**11.6 - RelayCfg (Relay Configuration)**

To associate one of the Output Relays to one or more functions (see § Password): enter the menu “R/W Set”, select “Relay Cfg”, select the “Relay #” to be programmed, select “Link”; at this stage the list of the available functions is displayed. Scrolling the list by the “+” and “-” keys the function is selected and then assigned by the key “Enter”. The assignation is confirmed by the function indication that switches from blinking to steady.

Any of the Output Relays can be programmed to work in two different modes:

- **N.D.** Normally Deenergized Relay is energized on trip of the associated functions
- **N.E.** Normally Energized Relay is deenergized on trip of the associated functions

Programming of working mode is made as above selecting “OpMode” instead of “Link”.





Relay	Display		Default Value	Description	Setting Range	Step
	Type					
R1	Link	→	T>, tI>, tI>>, tIH, tIo>, tIo>>, tIoH	Association of functions to output relay R1	T>, Ta, I>, tI>, I>>, tI>>, IH, tIH, lo>, tlo>, lo>>, tlo>>, tIoH, BF, RTD, IRF, HwRec, CBopen, CBclose, 1.D1, 1.D2, 1.D3, 1.D4, 1.D5, 1.D6, 1.D7, 1.D8, 1.D9, 1.D10, Canstatus, CBFail.	-
	OpMode	→	N.D.	N.D. (Normally Deenergized) N.E. (Normally Energized)	N.D./N.E.	-
R2	Link	→	BF	Association of functions to output relay R2	T>, Ta, I>, tI>, I>>, tI>>, IH, tIH, lo>, tlo>, lo>>, tlo>>, tIoH, BF, RTD, IRF, HwRec, CBopen, CBclose, 1.D1, 1.D2, 1.D3, 1.D4, 1.D5, 1.D6, 1.D7, 1.D8, 1.D9, 1.D10, Canstatus, CBFail.	-
	OpMode	→	N.D.	N.D. (Normally Deenergized) N.E. (Normally Energized)	N.D./N.E.	-
R3	Link	→	Ta, I>, I>>, IH, Io>, Io>>, IoH	Association of functions to output relay R3	T>, Ta, I>, tI>, I>>, tI>>, IH, tIH, lo>, tlo>, lo>>, tlo>>, tIoH, BF, RTD, IRF, HwRec, CBopen, CBclose, 1.D1, 1.D2, 1.D3, 1.D4, 1.D5, 1.D6, 1.D7, 1.D8, 1.D9, 1.D10, Canstatus, CBFail.	-
	OpMode	→	N.D.	N.D. (Normally Deenergized) N.E. (Normally Energized)	N.D./N.E.	-

**(UX10-4) Additional Expansion Module (10 Digital Input – 4 Output Relay)**

By the interface program “MCom 2” it is possible to Activate/Deactivate the modules.

Relay	Display		Default Value	Description	Setting Range	Step
	Type					
1.R1	Link	→	-	Association of functions to output relay 1.R1	T>, Ta, I>, tI>, I>>, tI>>, IH, tIH, lo>, tlo>, lo>>, tlo>>, tIoH, BF, RTD, IRF, HwRec, CBopen, CBclose, 1.D1, 1.D2, 1.D3, 1.D4, 1.D5, 1.D6, 1.D7, 1.D8, 1.D9, 1.D10, Canstatus, CBFail.	-
	OpMode	→	N.D.	N.D. (Normally Deenergized) N.E. (Normally Energized)	N.D./N.E.	-
1.R2	Link	→	-	Association of functions to output relay 1.R2	T>, Ta, I>, tI>, I>>, tI>>, IH, tIH, lo>, tlo>, lo>>, tlo>>, tIoH, BF, RTD, IRF, HwRec, CBopen, CBclose, 1.D1, 1.D2, 1.D3, 1.D4, 1.D5, 1.D6, 1.D7, 1.D8, 1.D9, 1.D10, Canstatus, CBFail.	-
	OpMode	→	N.D.	N.D. (Normally Deenergized) N.E. (Normally Energized)	N.D./N.E.	-
1.R3	Link	→	-	Association of functions to output relay 1.R3	T>, Ta, I>, tI>, I>>, tI>>, IH, tIH, lo>, tlo>, lo>>, tlo>>, tIoH, BF, RTD, IRF, HwRec, CBopen, CBclose, 1.D1, 1.D2, 1.D3, 1.D4, 1.D5, 1.D6, 1.D7, 1.D8, 1.D9, 1.D10, Canstatus, CBFail.	-
	OpMode	→	N.D.	N.D. (Normally Deenergized) N.E. (Normally Energized)	N.D./N.E.	-
1.R4	Link	→	-	Association of functions to output relay 1.R4	T>, Ta, I>, tI>, I>>, tI>>, IH, tIH, lo>, tlo>, lo>>, tlo>>, tIoH, BF, RTD, IRF, HwRec, CBopen, CBclose, 1.D1, 1.D2, 1.D3, 1.D4, 1.D5, 1.D6, 1.D7, 1.D8, 1.D9, 1.D10, Canstatus, CBFail.	-
	OpMode	→	N.E.	N.D. (Normally Deenergized) N.E. (Normally Energized)	N.D./N.E.	-







## 11.7 - Commands

-  “ Commands “
-  1<sup>st</sup> Control,
-  to select other available control,
-  to operate selected control.

Display	Description
<b>Clear</b>	: Erase memory of Trip Counters, Event Records.
<b>Test</b>	: Starts a relay diagnostic test
<b>Reset</b>	: Reset after trip
<b>CBopen</b>	: Manual Open - Close Breaker
<b>CBclose</b>	: Manual Close - Close Breaker

## 11.8 - Info&Ver (Firmware - Info&Version)

The menu displays the Relay Model and the Firmware Version

- “ **Real Time Meas** “ 
-  “ Info/Ver “,
-  “ Model XXXXXX “, Model Relay
-  “ RelayVrs ###.#.#X “, Firmware Version
-  to go back to “ Info&Ver “.
-  to go back to “ **Real Time Meas** “

12. Keyboard Operational Diagram

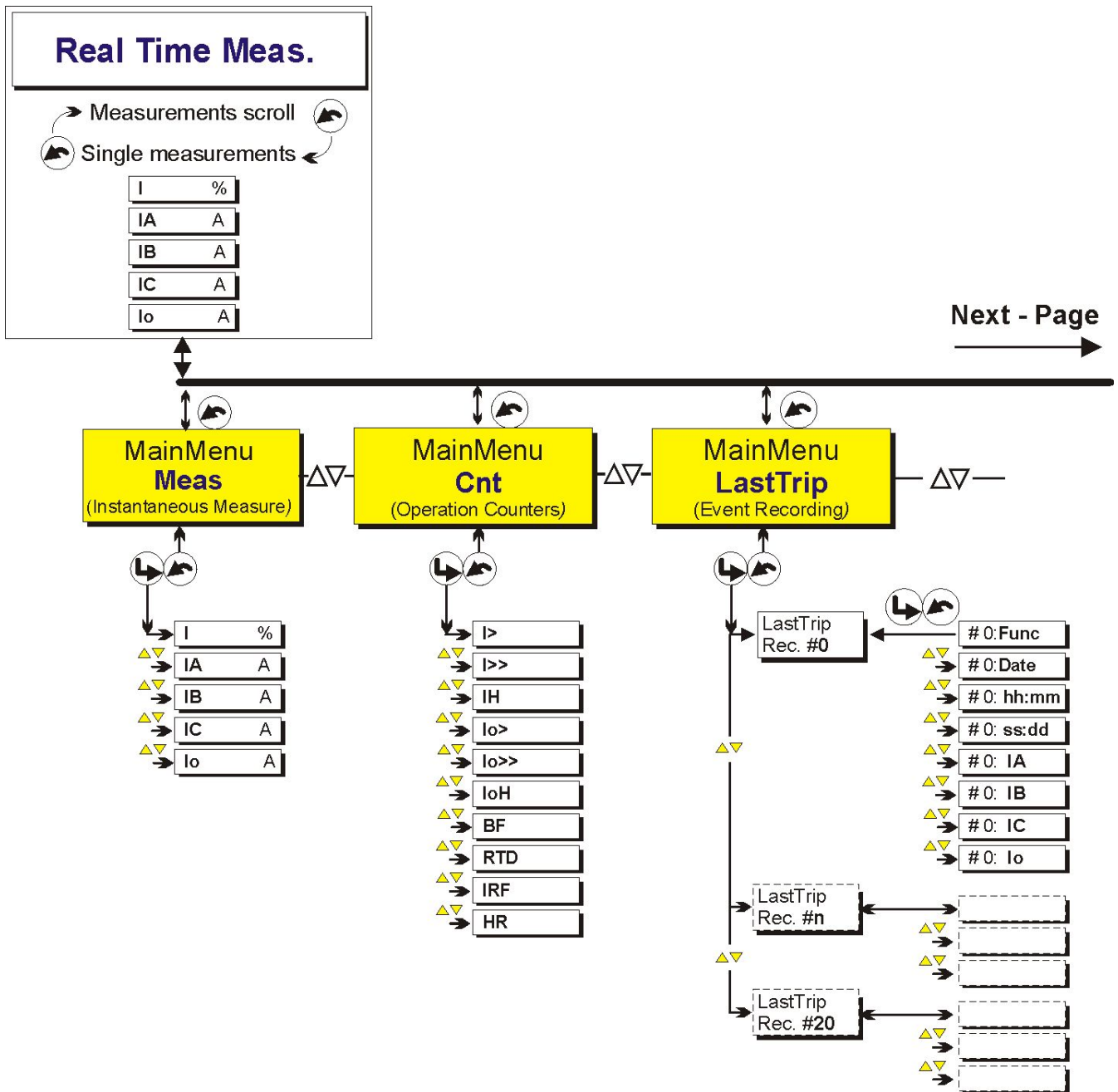

Previous - Page

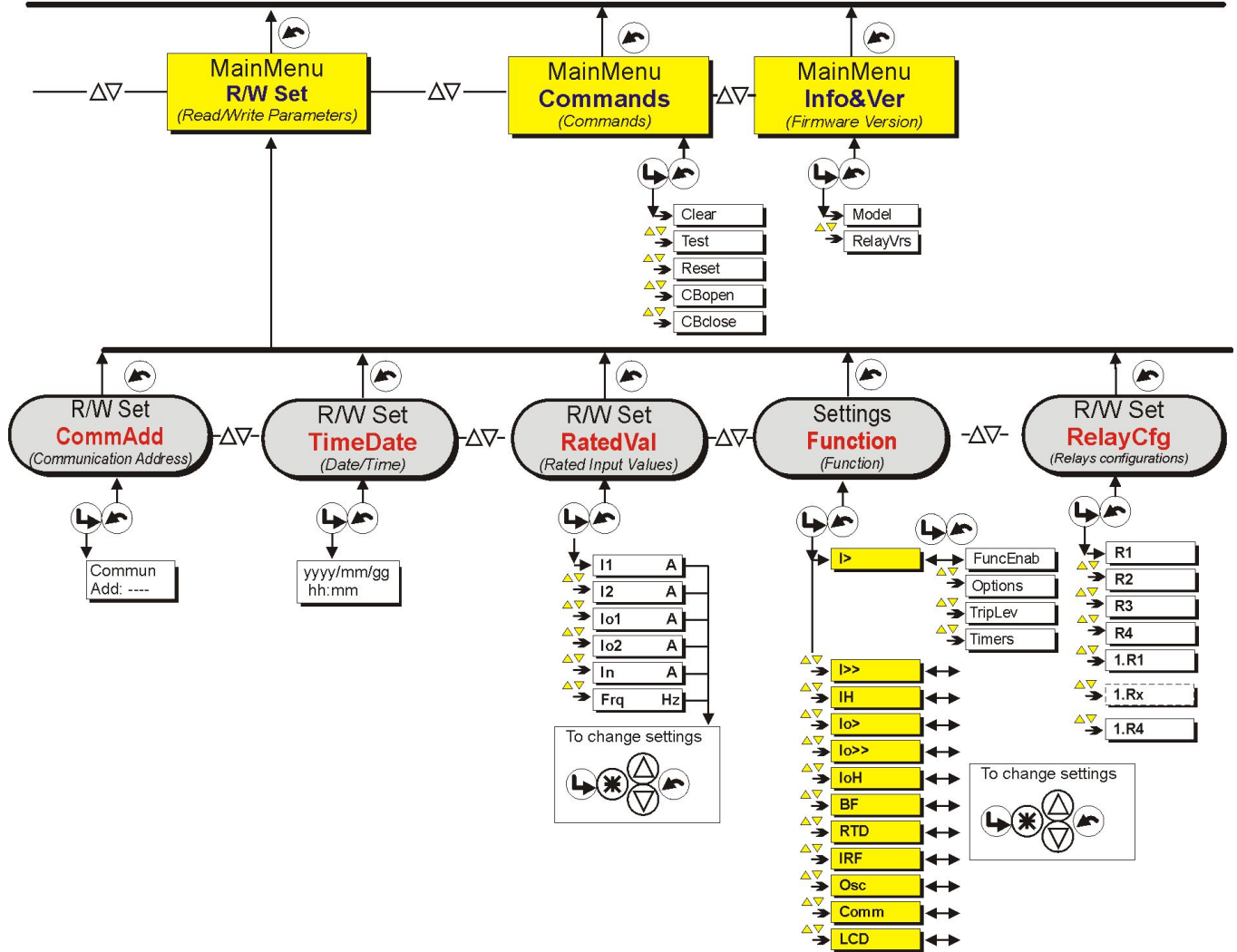

### 13. Password









---

This password is requested anytime the user wants to write in the “Settings” menu a command of the “Commands” menu.

The default password is “ 1111 “

When password is required, proceed as follows

The Display shows the message “ Password ????? “

- |   |   |                                       |   |                        |
|---|---|---------------------------------------|---|------------------------|
| - |  | to select 1 <sup>st</sup> digit (1-9) |  | to validate            |
| - |  | to select 2 <sup>nd</sup> digit (1-9) |  | to validate            |
| - |  | to select 3 <sup>rd</sup> digit (1-9) |  | to validate            |
| - |  | to select 4 <sup>th</sup> digit (1-9) |  | to complete procedure. |

The “ password “ is required any time you attempt to modify one of the programmable variables at the first entrance in the “Settings” and/or “Commands” menus.

The “ password “remains valid for 2 minutes from the last operation of the programming buttons or until the  button is pressed to return to the default display (RT Meas).

Once the Password has been entered, a “ # “ appears before the variable that can be modified.

#### 13.1 - MS-Com Password

---

This password is requested anytime the user wants to send to the relay a setting parameters modification or to issue a command through the relay itself using the managing software MSCom.

The user can decide whether inserting his own password (see MS-Com Operational Manual) or keeping the password disabled just clicking on the OK button when the password is requested.

### 14. Maintenance

---

No maintenance is required. In case of malfunctioning please contact Microelettrica Scientifica Service or the local Authorised Dealer mentioning the relay's Serial No reported in the label on relays enclosure.

### 15. Power Frequency Insulation Test

---

Every relay individually undergoes a factory insulation test according to IEC255-5 standard at 2 kV, 50 Hz 1min. Insulation test should not be repeated as it unusefully stresses the dielectrics.

When doing the insulation test, the terminals relevant to serial output, digital inputs and RTD input must always be short circuited to ground. When relays are mounted in switchboards or relay boards that have to undergo the insulation tests, the relay should be isolated. This is extremely important as discharges eventually tacking place in other parts or components of the board can severely damage the relays or cause damages not immediately evident to the electronic components.



16. Connection Diagram

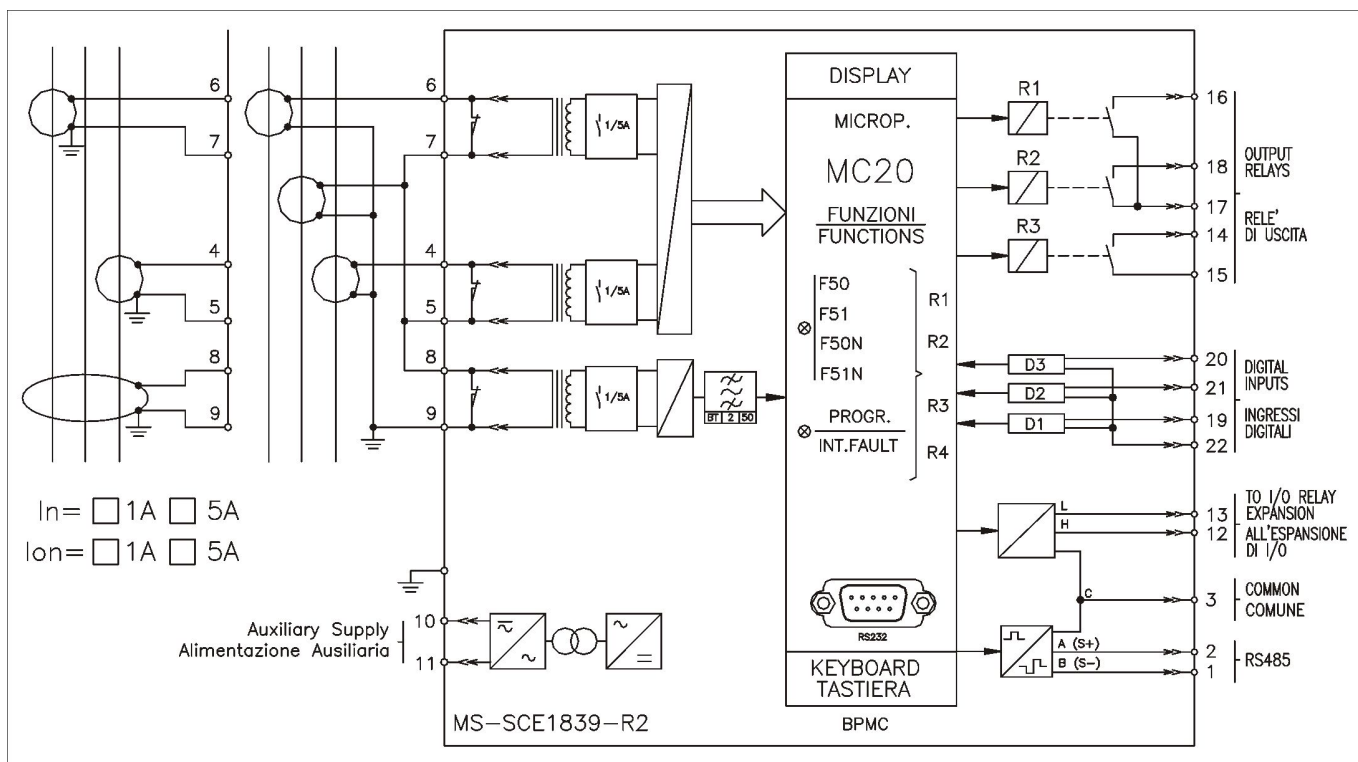

16.1 – UX10-4 - Expansion Module - Wiring Diagram (10 Digital Inputs + 4 Output Relays)

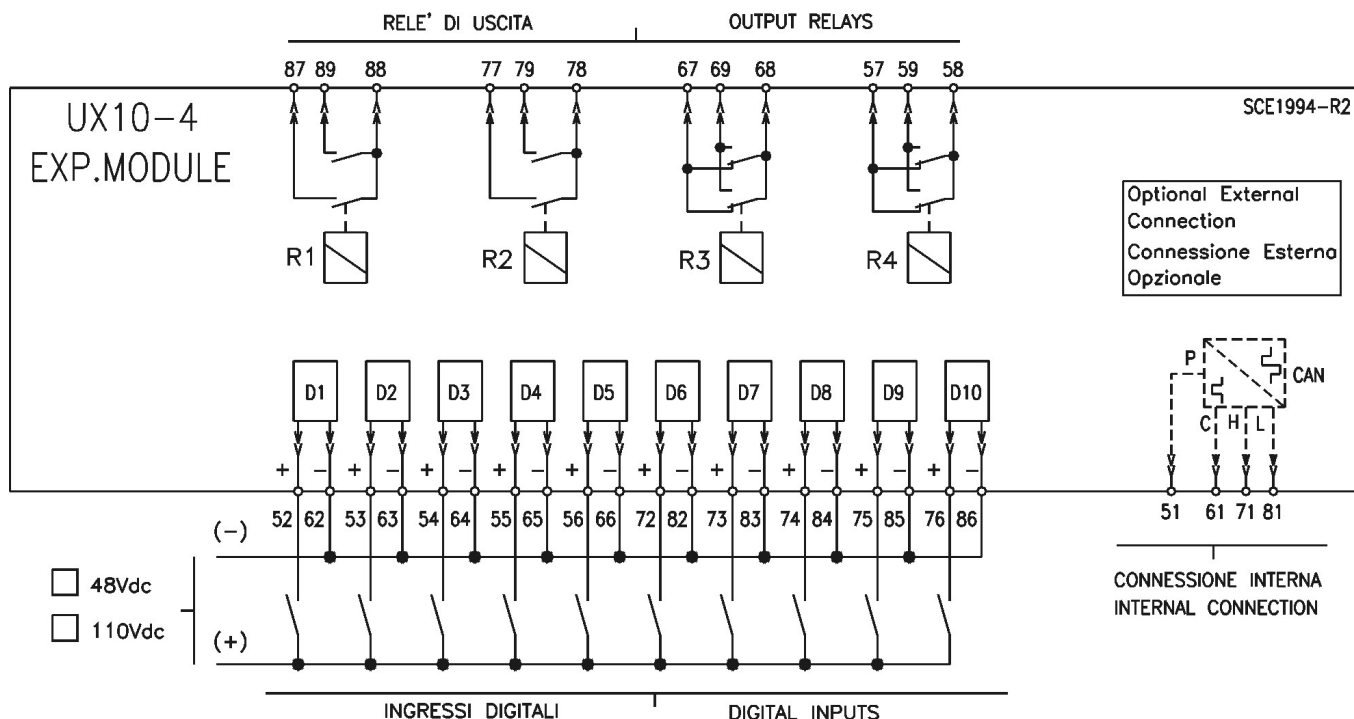



17. Overall Dimensions

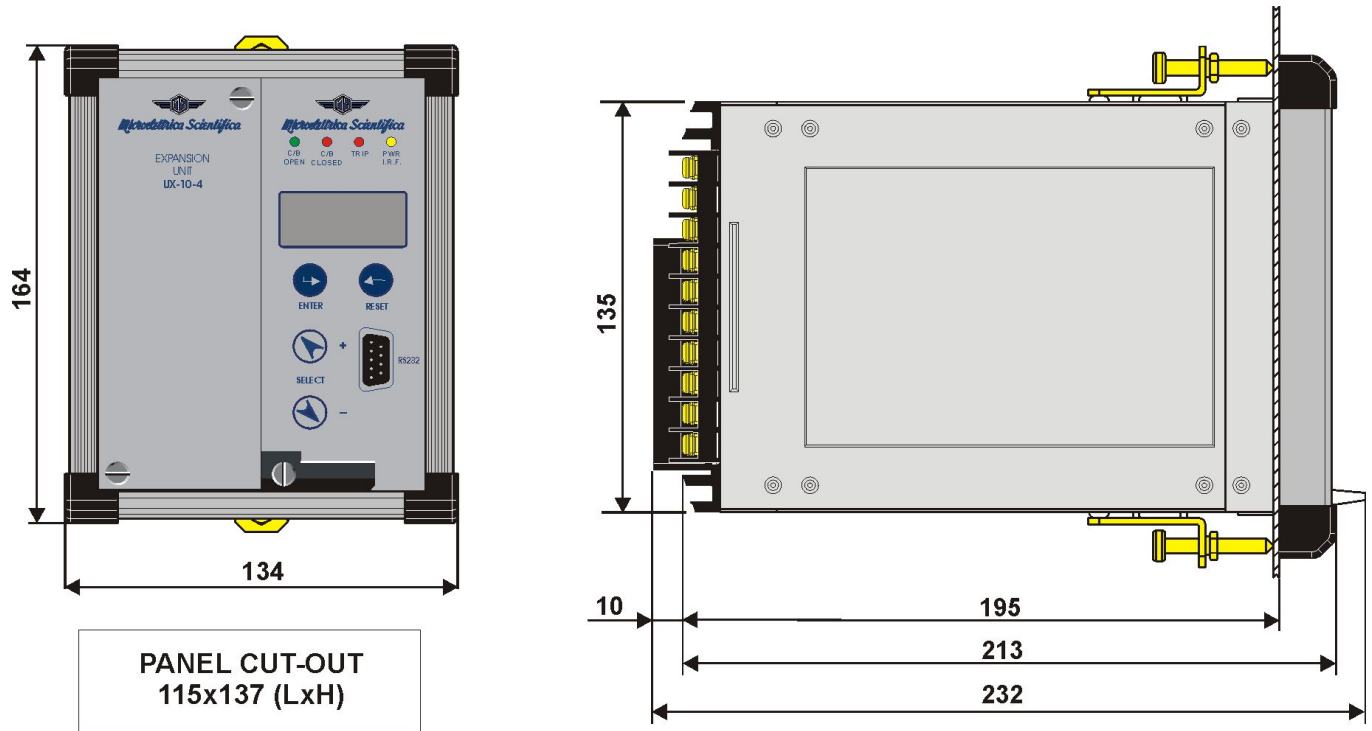

## 18. Direction for Pcb's Draw-Out and Plug-In

### 18.1 - Draw-Out

Rotate clockwise the screws ① in the horizontal position of the screws-driver mark.  
Draw-out the PCB by pulling on the handle ②

### 18.2 - Plug-In

Rotate clockwise the screws ① in the horizontal position of the screws-driver mark.  
Slide-in the card on the rails provided inside the enclosure.  
Plug-in the card completely and by pressing the handle to the closed position.  
Rotate anticlockwise the screws ① with the mark in the vertical position (locked).

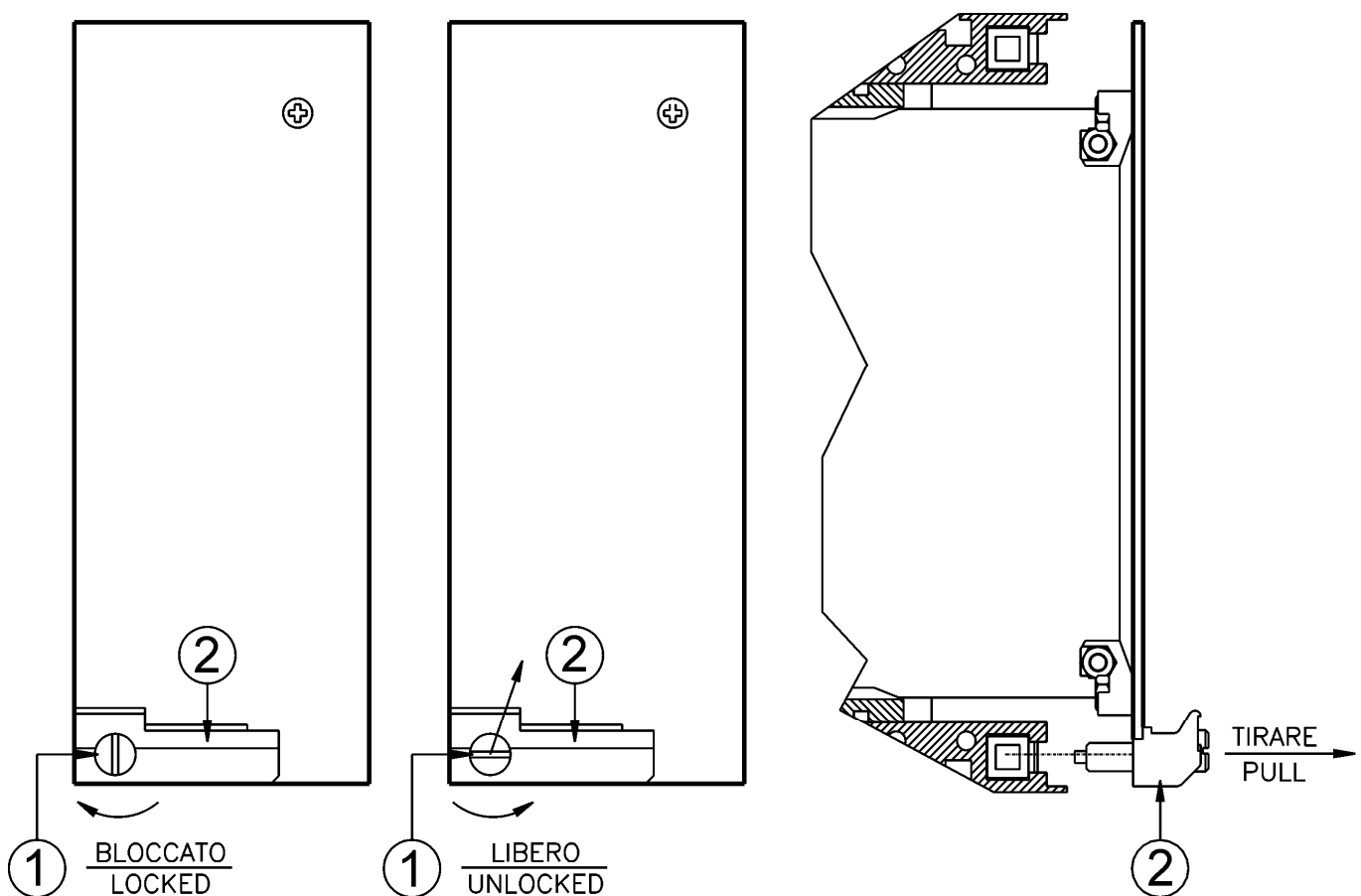

## 19. Electrical Characteristics

### APPROVAL: CE

### REFERENCE STANDARDS IEC 60255 - EN50263 - CE Directive - EN/IEC61000 - IEEE C37

<input type="checkbox"/>	Dielectric test voltage	IEC 60255-5	2kV, 50/60Hz, 1 min.
<input type="checkbox"/>	Impulse test voltage	IEC 60255-5	5kV (c.m.), 2kV (d.m.) – 1,2/50µs
<input type="checkbox"/>	Insulation resistance	> 100MΩ	

### Environmental Std. Ref. (IEC 60068)

<input type="checkbox"/>	Operation ambient temperature	-10°C / +55°C
<input type="checkbox"/>	Storage temperature	-25°C / +70°C
<input type="checkbox"/>	Environmental testing	(Cold) IEC60068-2-1 (Dry heat) IEC60068-2-2 (Change of temperature) IEC60068-2-14 (Damp heat, steady state) IEC60068-2-78
		RH 93% Without Condensing AT 40°C

### CE EMC Compatibility (EN50081-2 - EN50082-2 - EN50263)

<input type="checkbox"/>	Electromagnetic emission	EN55022	industrial environment
<input type="checkbox"/>	Radiated electromagnetic field immunity test	IEC61000-4-3 ENV50204	level 3 80-2000MHz 10V/m 900MHz/200Hz 10V/m
<input type="checkbox"/>	Conducted disturbances immunity test	IEC61000-4-6	level 3 0.15-80MHz 10V
<input type="checkbox"/>	Electrostatic discharge test	IEC61000-4-2	level 4 6kV contact / 8kV air
<input type="checkbox"/>	Power frequency magnetic test	IEC61000-4-8	1000A/m 50/60Hz
<input type="checkbox"/>	Pulse magnetic field	IEC61000-4-9	1000A/m, 8/20µs
<input type="checkbox"/>	Damped oscillatory magnetic field	IEC61000-4-10	100A/m, 0.1-1MHz
<input type="checkbox"/>	Immunity to conducted common mode disturbance 0Hz-150KHz	IEC61000-4-16	level 4
<input type="checkbox"/>	Electrical fast transient/burst	IEC61000-4-4	level 3 2kV, 5kHz
<input type="checkbox"/>	HF disturbance test with damped oscillatory wave (1MHz burst test)	IEC60255-22-1	class 3 400pps, 2,5kV (m.c.), 1kV (d.m.)
<input type="checkbox"/>	Oscillatory waves (Ring waves)	IEC61000-4-12	level 4 4kV(c.m.), 2kV(d.m.)
<input type="checkbox"/>	Surge immunity test	IEC61000-4-5	level 4 2kV(c.m.), 1kV(d.m.)
<input type="checkbox"/>	Voltage interruptions	IEC60255-4-11	
<input type="checkbox"/>	Resistance to vibration and shocks	IEC60255-21-1 - IEC60255-21-2	10-500Hz 1g

### ELECTRIC RATED VALUE

<input type="checkbox"/>	Accuracy at reference value of influencing factors (* ) $I_n, I_{on}$ = Nominal Current of the System's Current Transformer	2% $I_n$ (*) 0,2% $I_{on}$ (*) 2% + to (to=20÷30ms @ 2xls)	for measure for times
<input type="checkbox"/>	Rated Current	$I_n = 1A/5A$ - $I_{on} = 1A/5A$	
<input type="checkbox"/>	Current overload	400 A for 1 sec; 20A continuous	
<input type="checkbox"/>	Burden on current inputs	Phase : 0.05VA at $I_n = 1A$ ; 0.2VA at $I_n = 5A$ Neutral : 0.05VA at $I_{on} = 1A$ ; 0.2VA at $I_{on} = 5A$	
<input type="checkbox"/>	Average power supply consumption	≤ 7 VA	
<input type="checkbox"/>	Output relays	rating 6 A; $V_n = 250 V$ A.C. resistive switching = 1500VA (400V max) make = 30 A (peak) 0,5 sec. break = 0.3 A, 110 Vcc, L/R = 40 ms (100.000 op.)	

### COMMUNICATION PARAMETER

<input type="checkbox"/>	RS485 (Back)	9600/19200 bps – 8,e,1 - 8,e,1 - 8,o,1 – Modbus RTU or IEC60870-5-103
<input type="checkbox"/>	RS232 (Front)	9600/19200/38400/57600 – 8,n,1 – Modbus RTU